

Труба Skolan

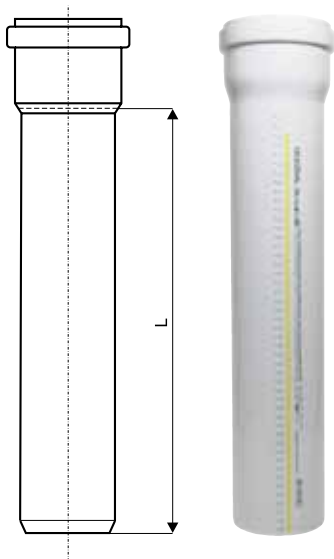

SKEM – труба с раструбом

Арт.	DN	L [мм]	Упаковка
332000	56	150	4/660
332010	56	250	4/440
332020	56	500	4/220
332040	56	1000	1/114
332060	56	2000	1/114
333300	70	150	4/360
333010	70	250	4/240
333020	70	500	4/152
333040	70	1000	1/70
333060	70	2000	1/70
334000	90	150	4/224
334010	90	250	4/168
334020	90	500	4/100
334040	90	1000	1/60
334060	90	2000	1/60
335000	100	150	4/180
335010	100	250	4/120
335020	100	500	2/78
335040	100	1000	1/40
335060	100	2000	1/40
336000	125	150	1/120
336010	125	250	1/96
336020	125	500	1/48
336040	125	1000	1/24
336060	125	2000	1/24
337000	150	150	1/84
337010	150	250	1/48
337020	150	500	1/35
337040	150	1000	1/21
337060	200	2000	1/21
338000	200	150	1/45
338010	200	250	1/30
338020	200	500	1/20
338040	200	1000	1/15
338060	200	2000	1/15

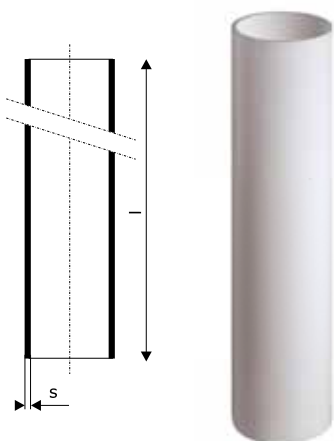

SKGL – труба без раструба

Арт.	DN	s [мм]	l [мм]	Упаковка
332080	56	4,0	3000	1/114
333080	70	4,5	3000	1/70
334065	90	4,5	2000	1/60
334080	90	4,5	3000	1/60
335080	100	5,3	3000	1/40
336080	125	5,3	3000	1/24
337080	150	5,3	3000	1/21
338080	200	6,2	3000	1/15

Фитинги Skolan

SKB – отвод 15°

Арт.	DN	α	z_1 [мм]	z_2 [мм]	Упаковка
332100	56	15°	6	8	4/1000
333100	70	15°	7	11	4/600
334100	90	15°	9	12,5	4/500
335100	100	15°	6	14	4/300
336100	125	15°	10	16	4/192
337100	150	15°	24	19	4/100
338100	200	15°	15	31	1/40

SKB – отвод 30°

Арт.	DN	α	z_1 [мм]	z_2 [мм]	Упаковка
332110	56	30°	10	15	4/1000
333110	70	30°	12	15	4/600
334110	90	30°	13	18,5	4/480
335110	100	30°	17	21	4/300
336110	125	30°	20	24,5	4/160
337110	150	30°	24	34	4/100
338110	200	30°	29	46	1/40

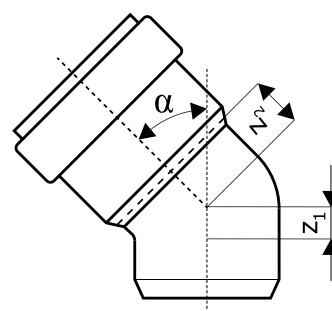

SKB – отвод 45°

Арт.	DN	α	z_1 [мм]	z_2 [мм]	Упаковка
332120	56	45°	14	16	4/1000
333120	70	45°	18	31	4/600
334120	90	45°	20	25,5	4/400
335120	100	45°	25	29	4/240
336120	125	45°	30	34	4/140
337120	150	45°	37	45	4/60
338120	200	45°	46	57	1/38



SKB – отвод 67°

Арт.	DN	α	z_1 [мм]	z_2 [мм]	Упаковка
332130	56	67°	23	21	4/880
333130	70	67°	28	31	4/500
335130	100	67°	40	44	4/200

SKB – отвод 87°

Арт.	DN	α	z_1 [мм]	z_2 [мм]	Упаковка
332140	56	87°	32	35	4/880
333140	70	87°	40	43	4/480
334140	90	87°	46	49,4	4/320
335140	100	87°	69	70,5	4/220
336140	125	87°	96	102	4/96
337140	150	87°	84	91	2/60

SKEA – тройник 45°

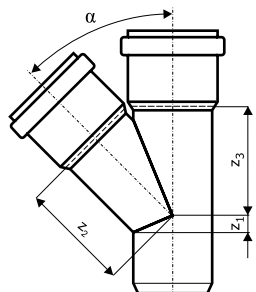

Арт.	DN	α	z_1 [мм]	z_2 [мм]	z_3 [мм]	Упаковка
332200	56/56	45°	13	74	74	4/60
333210	70/56	45°	3	88	85	4/320
333200	70/70	45°	20	98	98	4/260
334220	90/56	45°	3	97	84	4/264
334210	90/70	45°	12	105	103	4/216
334200	90/90	45°	20	110	110	4/180
335220	100/56	45°	17	108	95	4/180
335210	100/70	45°	6	122	115	4/140
335200	100/100	45°	25	136	136	4/100
336210	125/100	45°	11	155	152	2/70
336200	125/125	45°	49	169	169	2/56
337210	150/100	45°	2	168	159	2/46
337200	150/150	45°	36	194	194	2/28
338210	200/150	45°	19	221	218	1/20
338200	200/200	45°	46	244	244	1/15

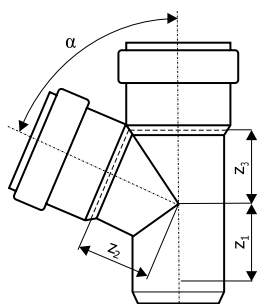

SKEA – тройник 67°

Арт.	DN	α	z_1 [мм]	z_2 [мм]	z_3 [мм]	Упаковка
332300	56/56	67°	22	45	45	4/500
333310	70/56	67°	18	55	51	4/360
333300	70/70	67°	29	61	61	4/280
335320	100/56	67°	21	73	57	4/180
335310	100/70	67°	22	81	67	4/140
335300	100/100	67°	40	84	84	4/120

SKEA – тройник 87°

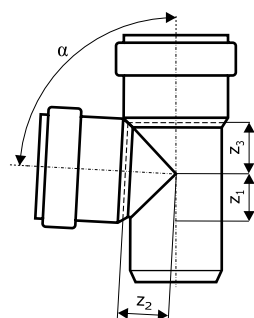

Арт.	DN	α	z_1 [мм]	z_2 [мм]	z_3 [мм]	Упаковка
332400	56/56	87°	33	34	34	4/500
333410	70/56	87°	32	43	32	4/360
333400	70/70	87°	40	43	43	4/320
334420	90/56	87°	32	48	31	4/320
334410	90/70	87°	43	49	40	4/240
334400	90/90	87°	56	70	51	4/160
335420	100/56	87°	28	60	32	4/200
335410	100/70	87°	40	60	45	4/160
335400	100/100	87°	57	59	59	4/140
336410	125/100	87°	70	73	72	4/80
336400	125/125	87°	70	72	72	2/80

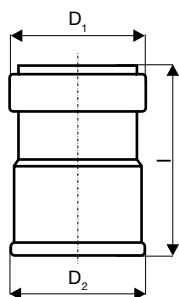

SKAM – насадная муфта

Арт.	DN	D_1 [мм]	D_2 [мм]	l [мм]	Упаковка
332810	56	74	79	117	4/1000
333810	70	95	100	119	4/640
334810	90	108	110	120	4/416
335810	100	129	132	124	4/300
336810	125	156	159	142	4/160
337810	150	183	184	144	4/120
338810	200	235	225	228	1/45

SKL – длинная муфта (патрубок компенсационный)

Арт.	DN	D ₁ [мм]	l [мм]	Упаковка
335930	100	110	196	4/200

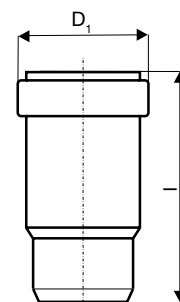
**SKM – заглушка**

Арт.	DN	L [мм]	Упаковка
332620	56	49	4/2380
333620	70	52	4/1372
334620	90	38	4/720
335620	100	57	4/720
336620	125	60	4/376
337620	150	49	4/260
338620	200	84	1/160

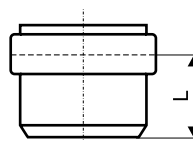
**SKU – подвижная муфта (ремонтная)**

Арт.	DN	l [мм]	Упаковка
332500	56	105	4/1100
333500	70	107	4/640
334500	90	98	4/320
335500	100	125	4/300
336500	125	123	4/180
337500	150	129	4/96
338500	200	239	1/54

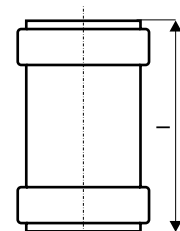
**SK – Переходник на НТ-трубу**

Арт.	DN	L [мм]	l [мм]	Упаковка
332820	56	50	52	4/2200
333820	70	59	112	4/800

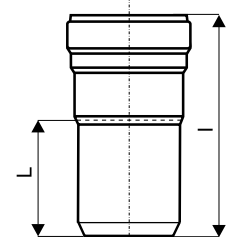
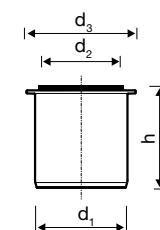
**SK – Переходник на НТ/KG***

Арт.	DN	L [мм]	l [мм]	Упаковка
336820	125	64	255	4/200

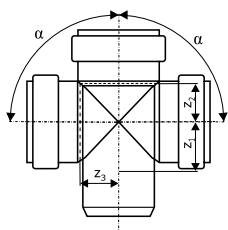

* (Поставляется вместе с насадной муфтой DN 125)

**SKDA – крестовина 87°**

Арт.	DN	α	z_1 [мм]	z_2 [мм]	z_3 [мм]	Упаковка
334900	90/90/90	87°	46	51	51	1/121
335900	100/100/100	87°	56	60	60	4/80

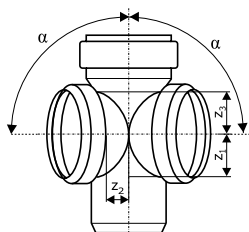
**SKED – крестовина двухплоскостная 87°**

Арт.	DN	α	z_1 [мм]	z_2 [мм]	z_3 [мм]	Упаковка
335910	100/100/100	87°	59	73	62	1/72

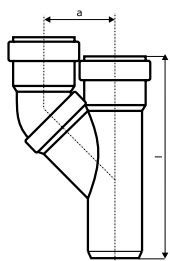
**SKPA – тройник параллельный**

Арт.	DN	z_1 [мм]	a [мм]	l [мм]	Упаковка
335920	100/100	199,5	129	320	2/90

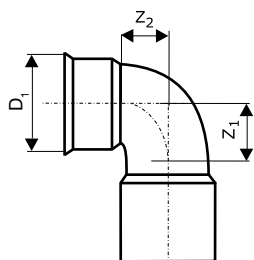
**SKSW – отвод для сифона 90°** (Резиновое уплотнение для отвода для сифона см. Комплектующие)

Арт.	DN	D_1 [мм]	z_1 [мм]	z_2 [мм]	Упаковка
335940	56/40	50	30,5	25	4/1200

SKR – редукция (переход эксцентрический)

Арт.	DN	I [мм]	L [мм]	Упаковка
333710	70/56	102	60	4/1000
334720	90/56	84	65	4/864
334710	90/70	105	60	4/800
335720	100/56	102	61	4/800
335710	100/70	102	61	4/800
335700	100/90	127	58	4/540
336710	125/110	133	90	4/240
337710	150/100	195	100	4/240
337700	150/125	190	100	1/120
338710	200/150	272	143	1/60

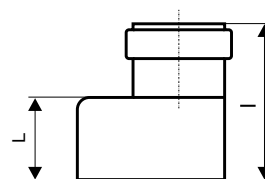
**SKRHT – переход редукционный Skolan/HT**

Арт.	DN	I [мм]	L [мм]	Упаковка
332750	56/40	89	60	4/1000
333750	70/50	110	76	4/1140

**SKRE – ревизия**

Арт.	DN	L [мм]	Упаковка
332600	56	151	4/480
333600	70	208	4/320
334600	90	170	4/240
335600	100	298	4/96
336600	125	316	2/40
337600	150	380	1/40
338600	200	380	1/20

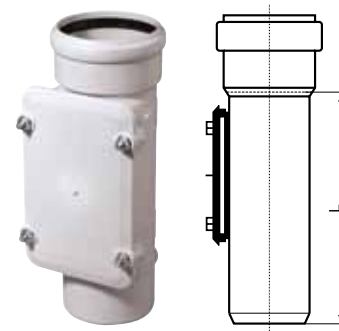

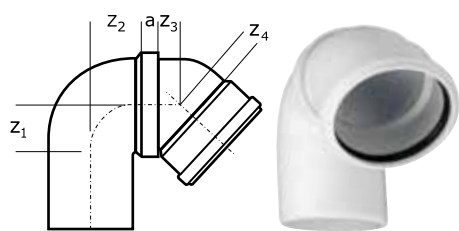
**SKUB – отвод сифонный 135°**

Арт.	DN	α	Z ₁ [мм]	Z ₂ [мм]	Z ₃ [мм]	Z ₄ [мм]	a [мм]	Упаковка
335950	100/100/100	135°	78	58	44	44	19,5	1/110

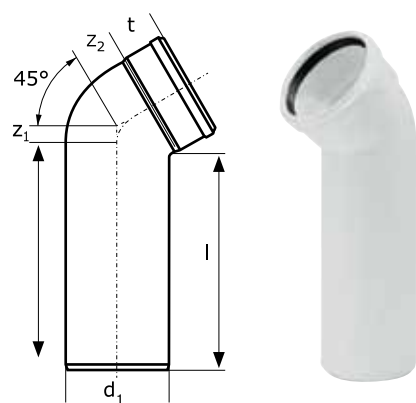
**SKLB – отвод удлиненный 45°**

Арт.	DN	α	t [мм]	l [мм]	D ₁ [мм]	Z ₁ [мм]	Z ₂ [мм]	Упаковка
335960	100	45°	57	250	110	24	28	2/112

Skolan – комплектующие

SK – уплотнительное кольцо

Арт.	DN	Упаковка
880600	56	-
880610	78	-
880620	90	-
880630	100	-
880640	125	-
880650	150	-
880660	200	-

SK – NBR уплотнение (маслостойкое)

Арт.	DN	Упаковка
880700	56	-
880710	70	-
880720	90	-
880730	100	-
880740	125	-
880750	150	-
880760	200	-

**SK – Манжета резиновая**

Арт.	DN	Упаковка
881210	40/30 B	20
881220	40/40 C	20

Манжеты для насадных муфт SK

Арт.	DN	Упаковка
881440	56	-
881450	70	-
881460	90	-
881470	100	-
881480	125	-
881490	150	-
881495	200	-

Skolan – комплектующие**SK – Страховочный хомут**

Арт.	DN	Наружный диаметр трубы мм	картон	Упаковка
881505	DN 56	56	50	1
881515	DN 78	78	30	1
881520	DN 90	90	20	1
881530	DN 110	110	20	1
881545	DN 135	135	9	1
881550	DN 160	160	10	1

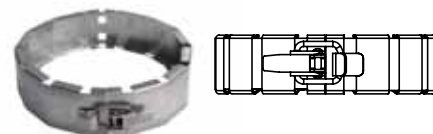
**SK – Ostendorf BS противопожарная манжета**

Арт.	Наружный диаметр трубы мм	картон	Упаковка
881605	56	25	1
881610	75–78	25	1
881620	90	10	1
881630	110	10	1
881650	160	5	1

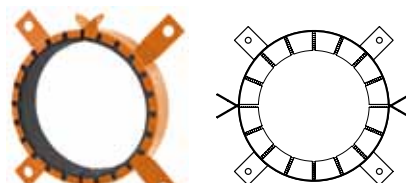
**SK – Страховочные хомуты для заглушек**

Арт.	DN	Упаковка
839010	56	-
839020	70	-
839030	90	-
839040	100	-
839050	125	-
839060	150	-

**SK – Соединительный хомут для стальных труб системы SML**

Арт.	DN	Упаковка
839080	56	-
839090	70	-
839100	90	-
839110	100	-
839120	125	-
839130	150	-

**Sk – техническая смазка**

Арт.	мл	Упаковка
881210	150	50/1750
881220	250	50/1500
881820	500	24/720

